

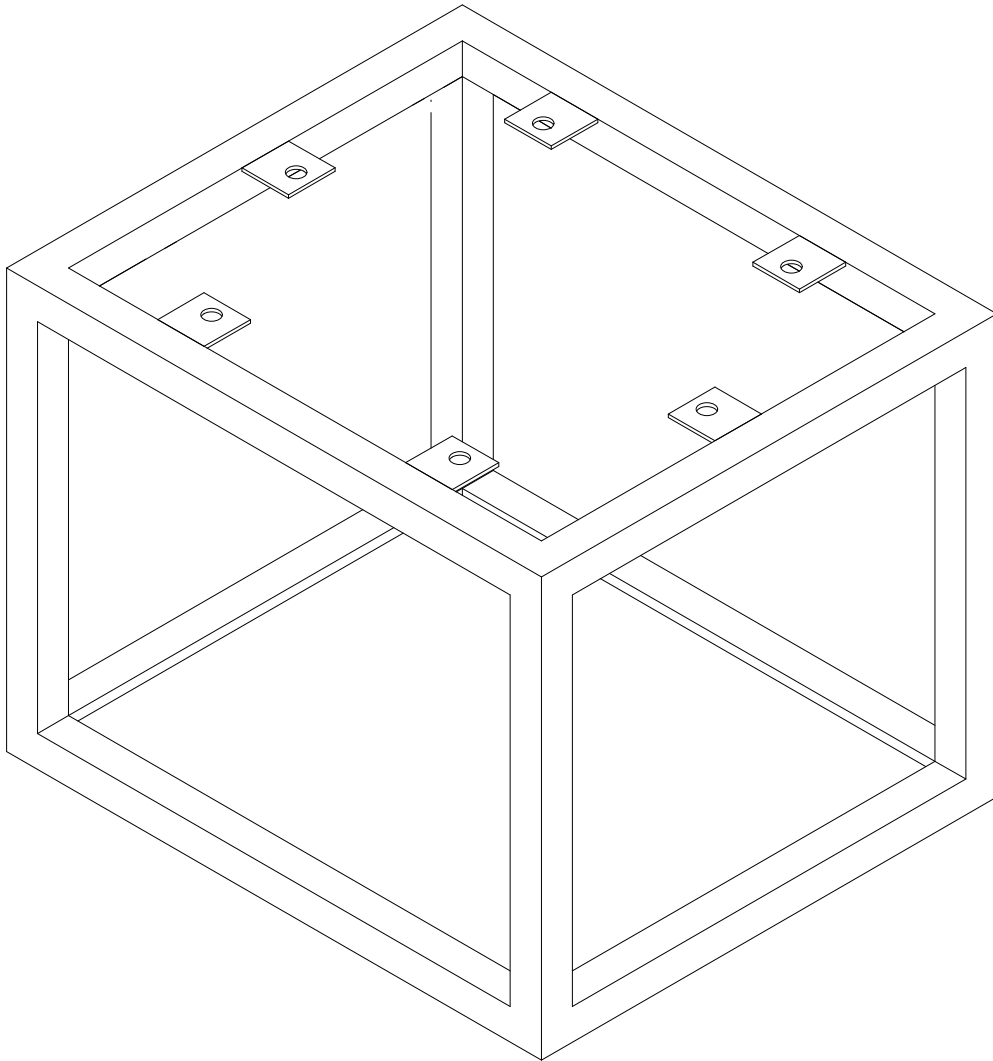

SAT

BWAY35FRAME



1

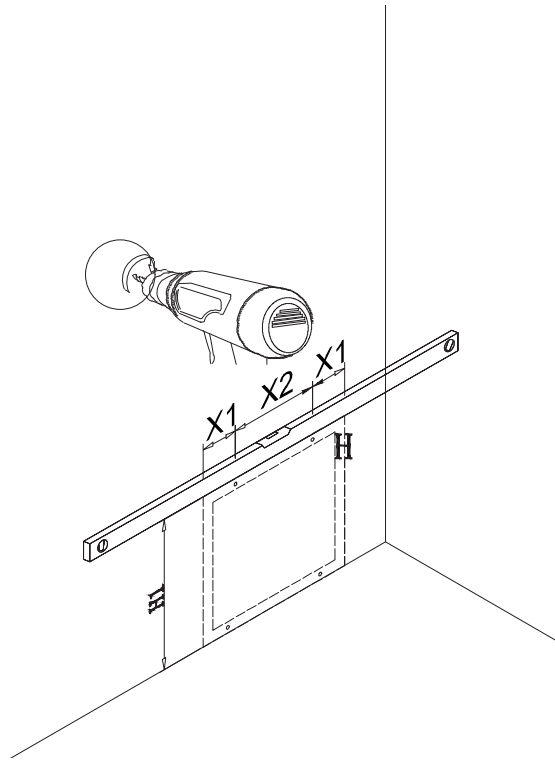
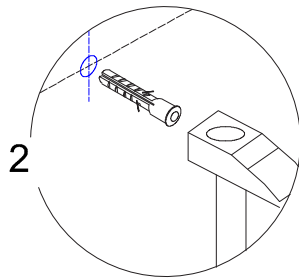
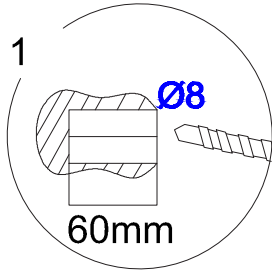
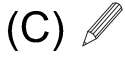

2

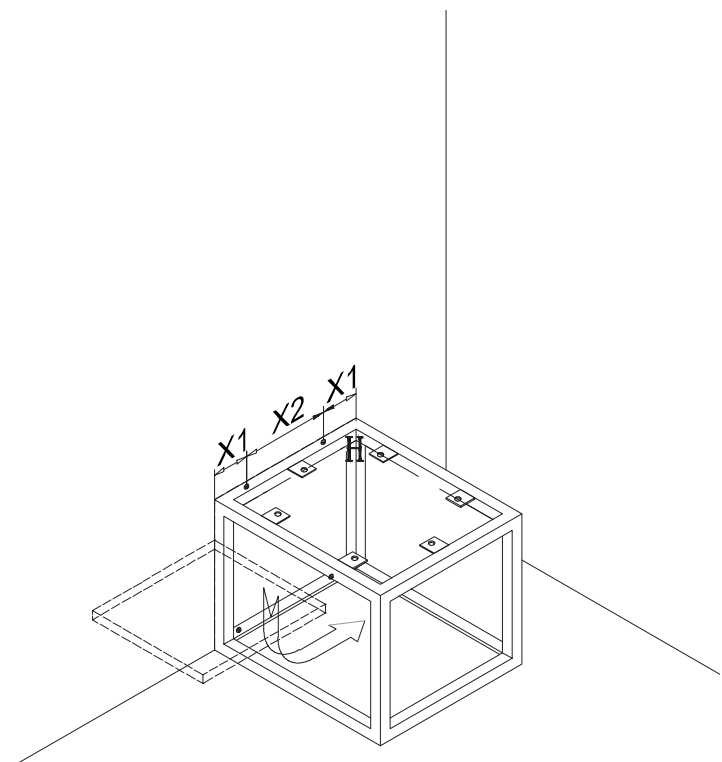
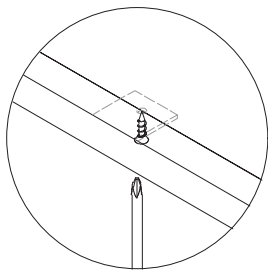

3

(d) 

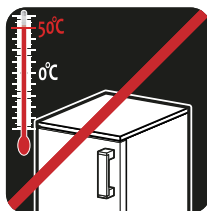
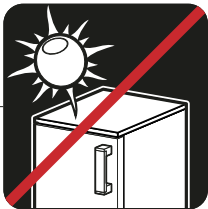
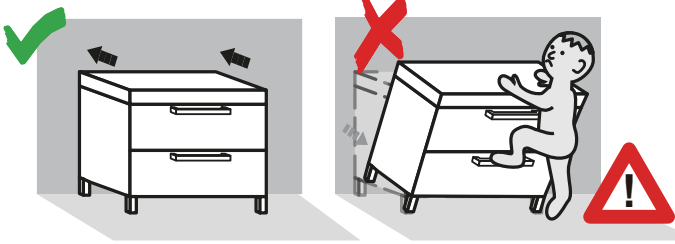
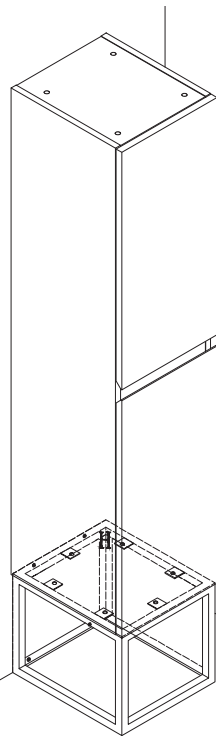
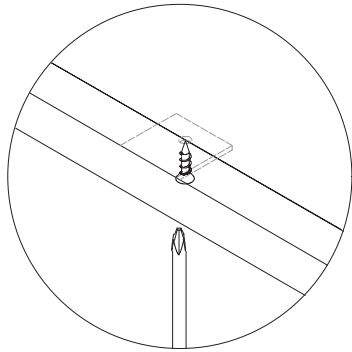

SAT® is registered trademark of



**Swiss
Aqua
Technologies**

Swiss Aqua Technologies AG
Gewerbstrasse 9, 6330 Cham, Switzerland
www.swatec.ch
Imported by SIKO KOUPELNY a.s.
Made in P.R.C.



SAT

BWAY35W
BWAY350AK

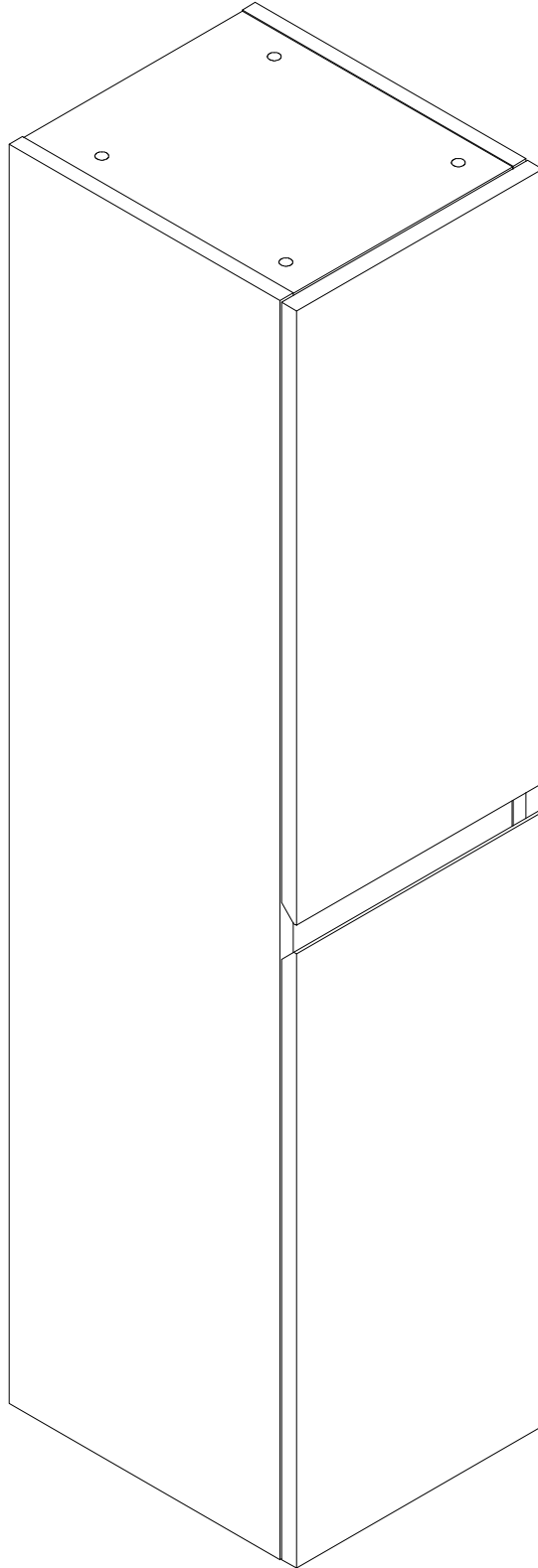

1

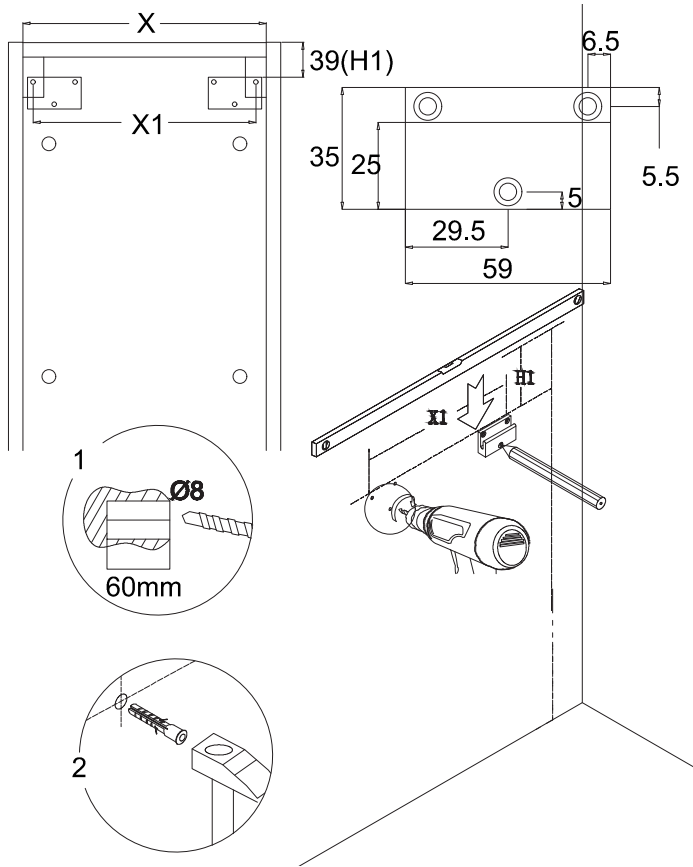
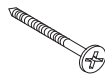

2

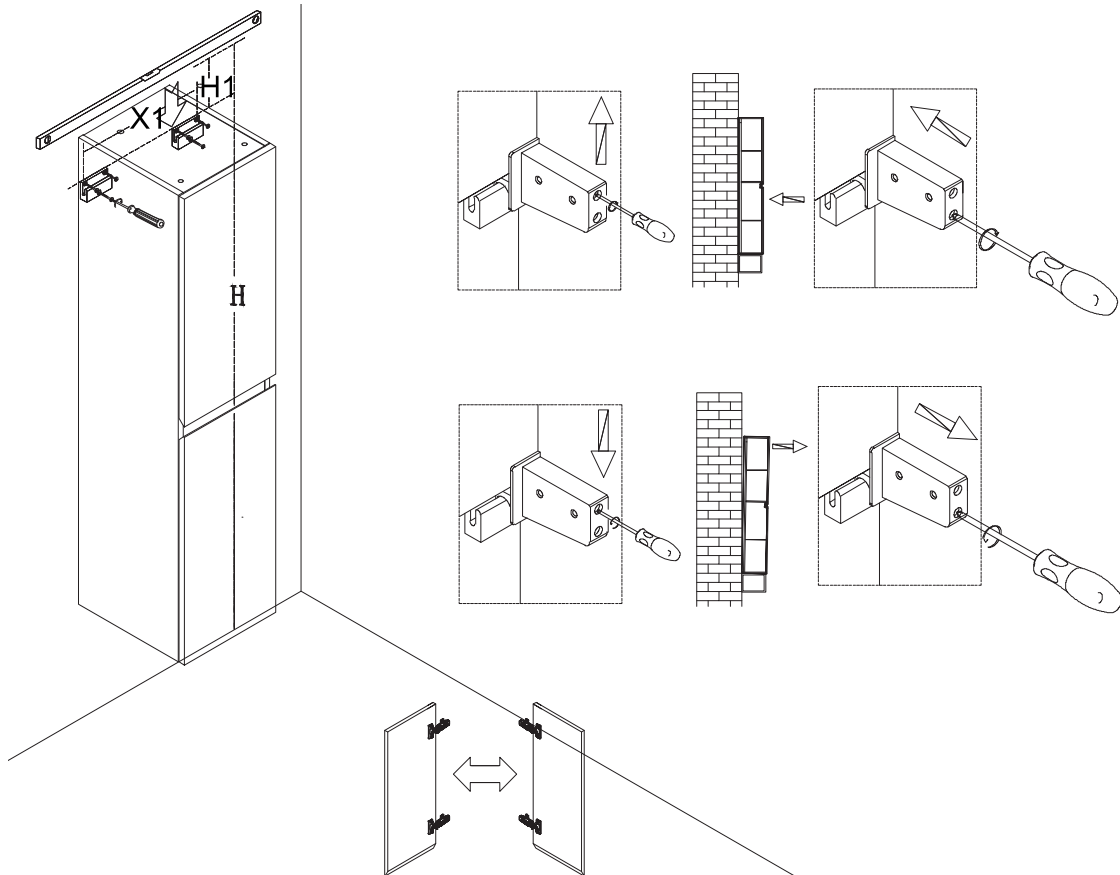

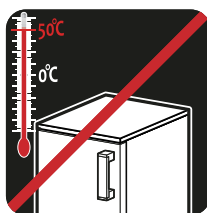
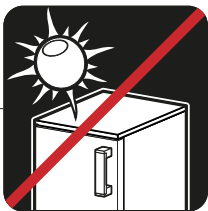
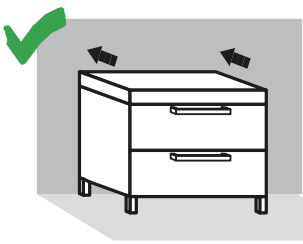
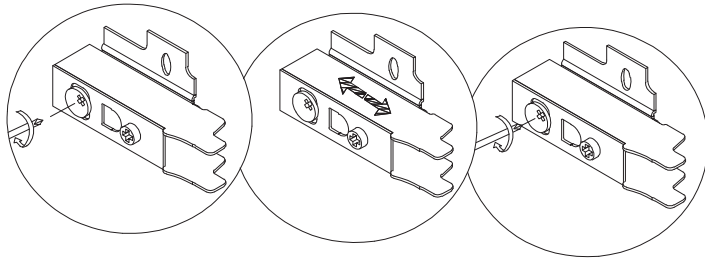
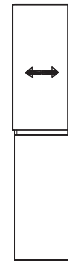
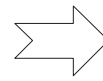
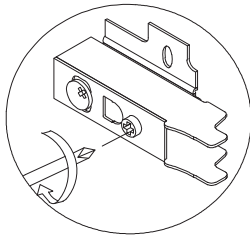
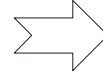
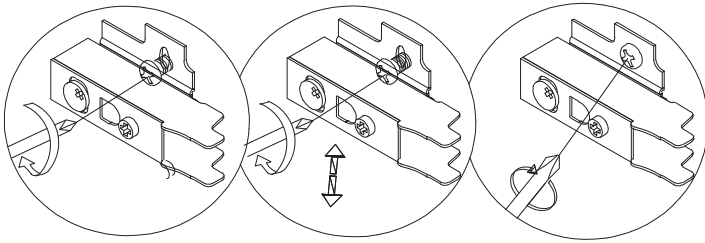
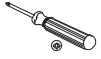

SAT® is registered trademark of



**Swiss
Aqua
Technologies**

Swiss Aqua Technologies AG
Gewerbstrasse 9, 6330 Cham, Switzerland
www.swatec.ch
Imported by SIKO KOUPELNY a.s.
Made in P.R.C.