

- 060..
- 065..
- 070..
- 071..
- 072..
- 074..
- 075..
- 076..
- 077..
- 078..
- 120..
- 125..
- 130..
- 131..
- 135..
- 136..
- 137..
- 138..
- 180..
- 181..
- 182..
- 183..
- 184..
- 190..

COMPATIBILITY:

QTV
FBLV/FCMV/FMEV
IRV/VLV
NI
DA
ET



1

Montaggio Assembly

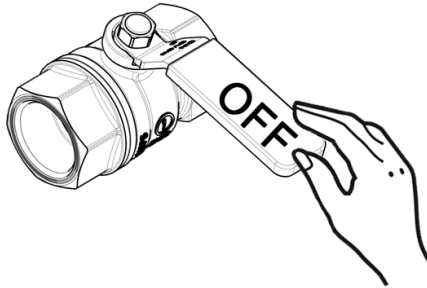

$65 \pm 5^{\circ}\text{C}$



$15 \pm 5^{\circ}\text{C}$

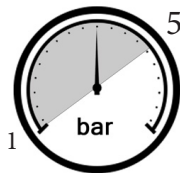

MIN - MAX

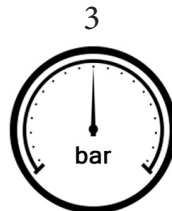

OK

2 a

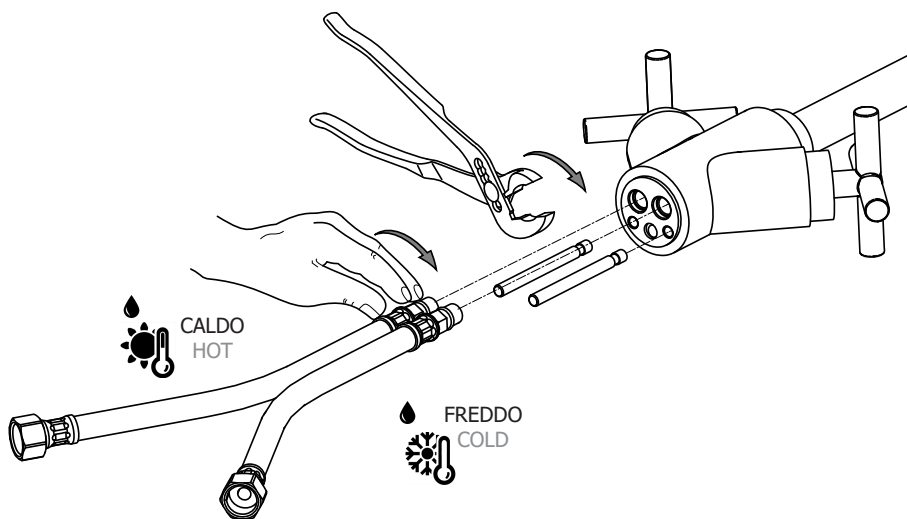

b

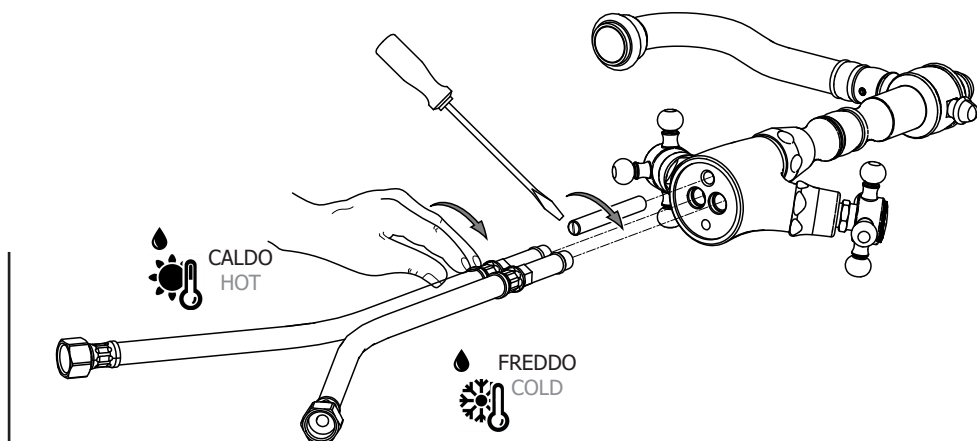

C

QTV

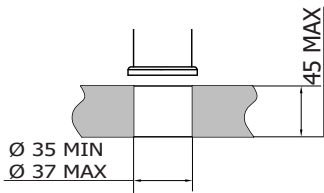

DA
ET

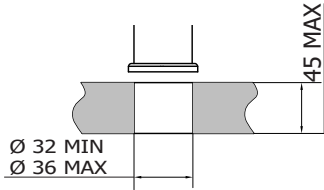

FBLV
FCMV
FMEV

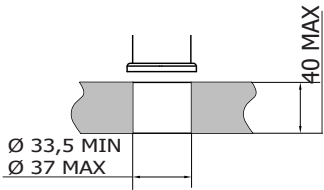

IRV
VLV

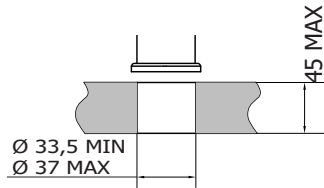

NI

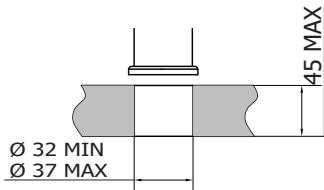

NI
072
074
076
078
180
182

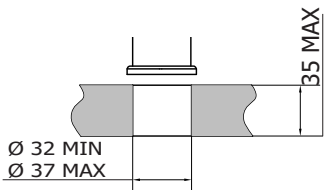

3

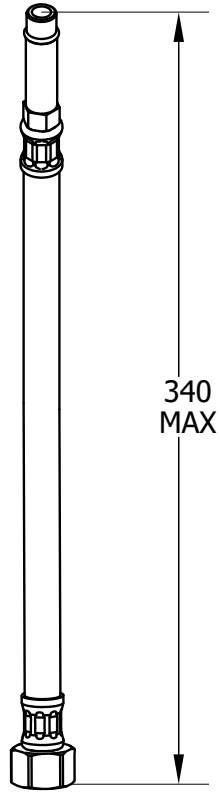
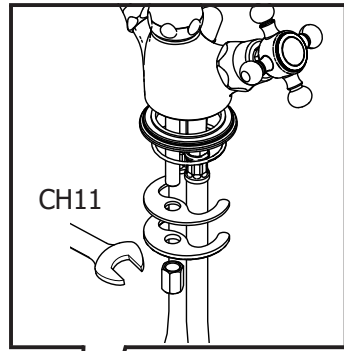
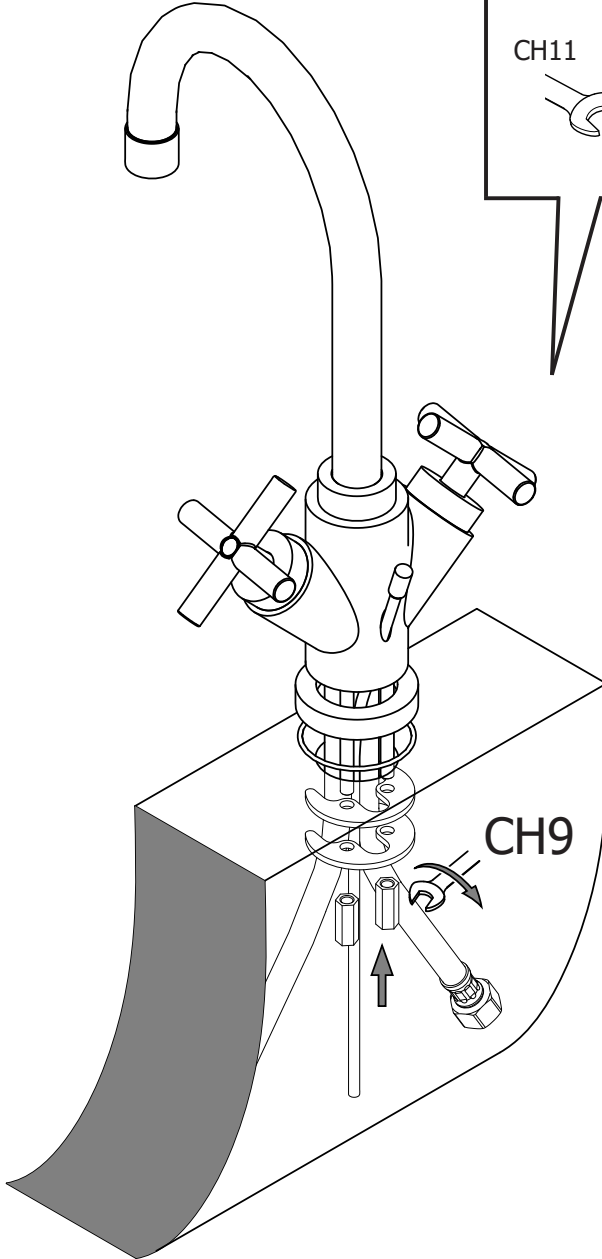

Attacco Lavastoviglie
Dish Washer Machine Connection

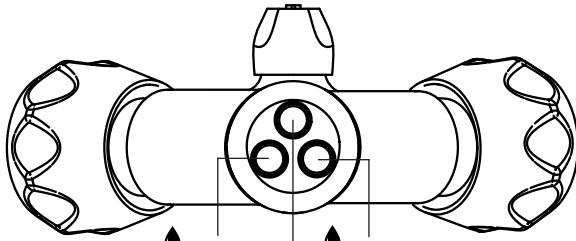

CALDO
HOT

FREDDO
COLD

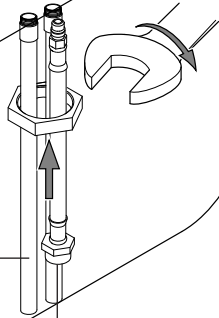
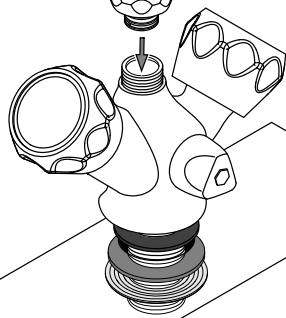
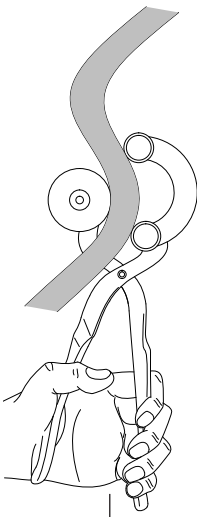
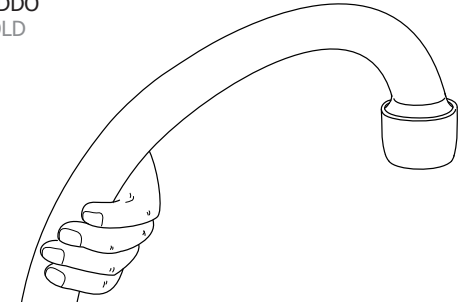

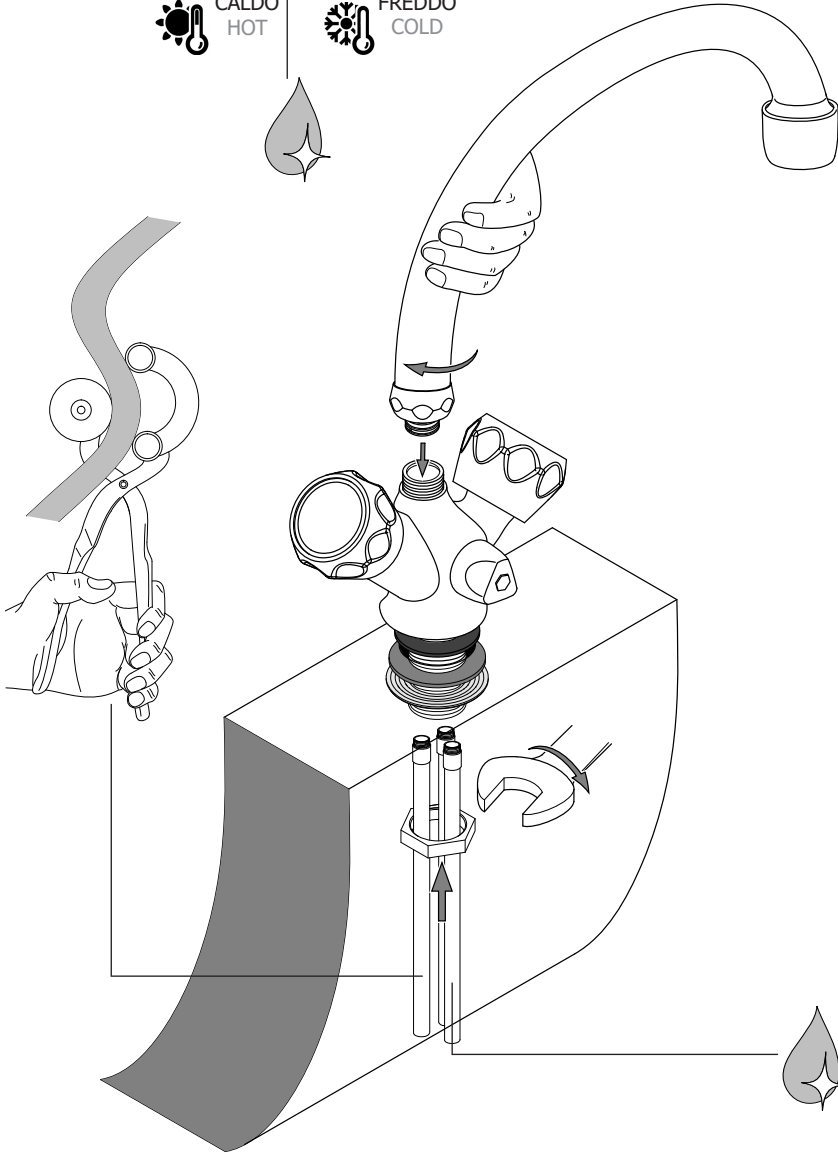
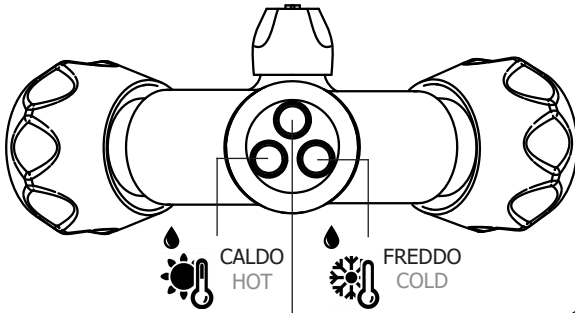

4 a

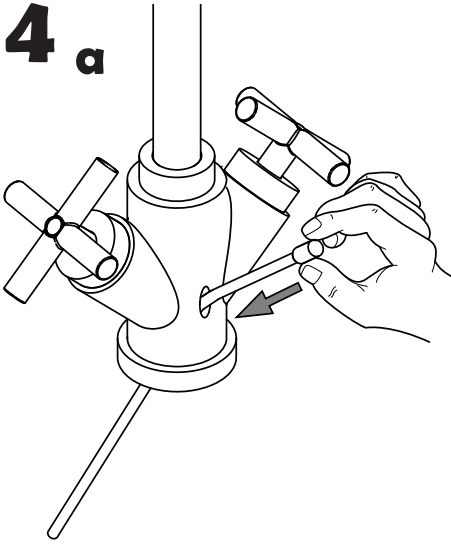

b

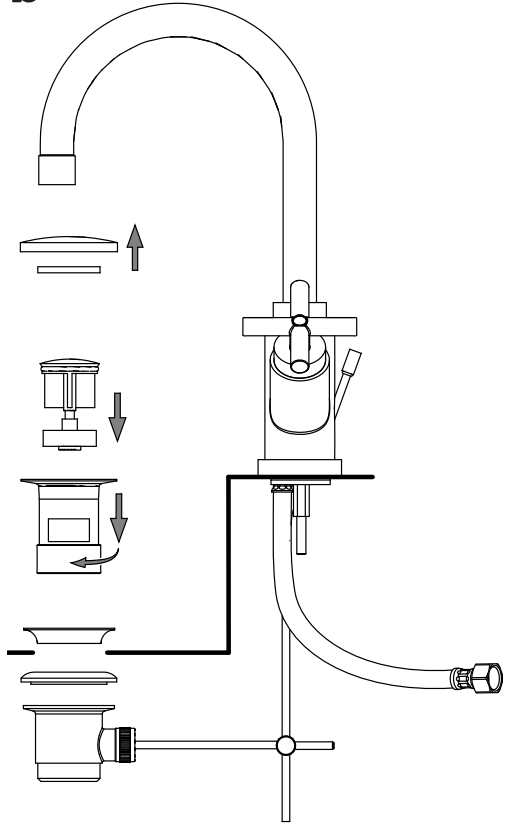

c

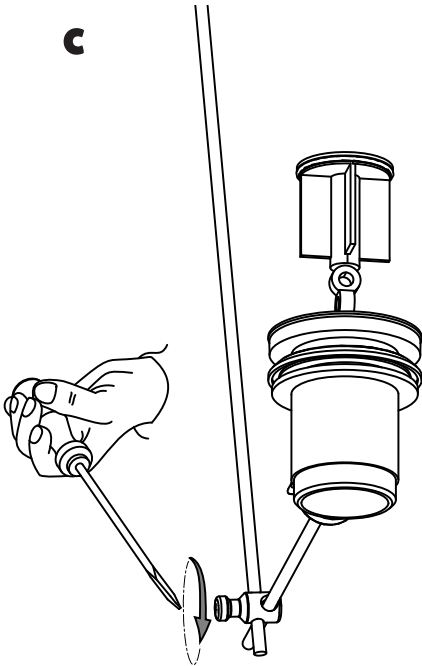

M

Manutenzione Service

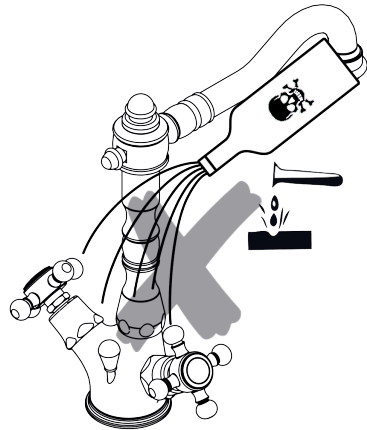
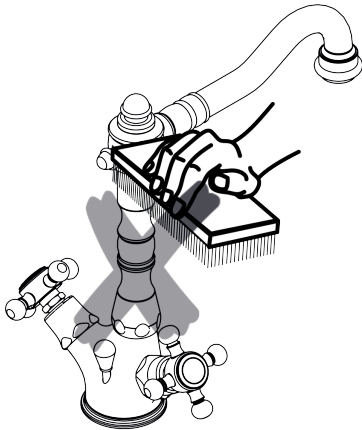
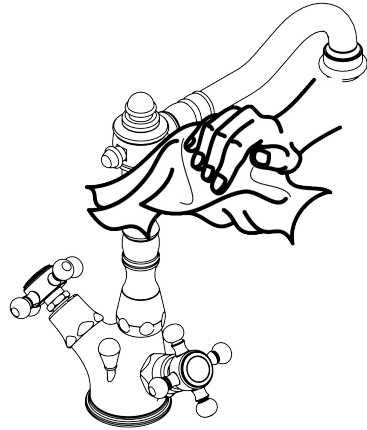
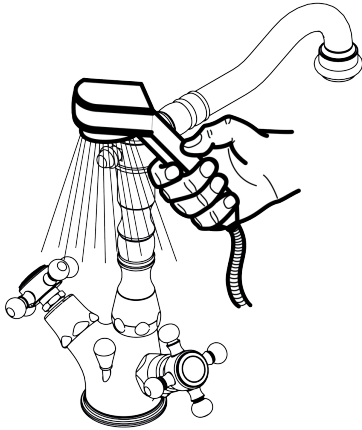
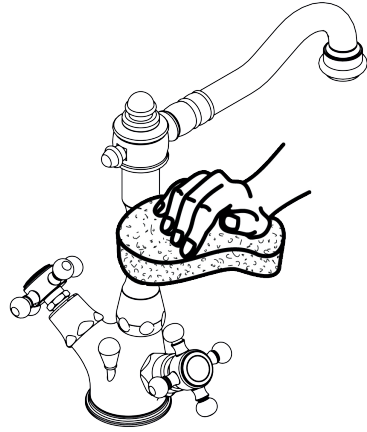
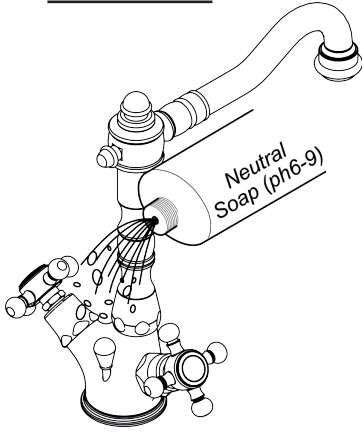

S a

Sostituzione Vitone How to Ceramic Disk Valve

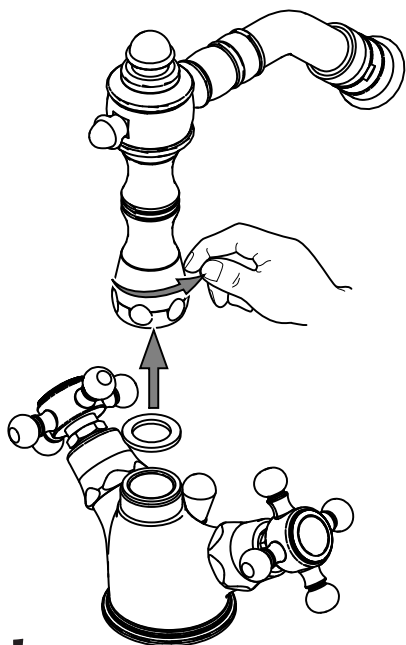
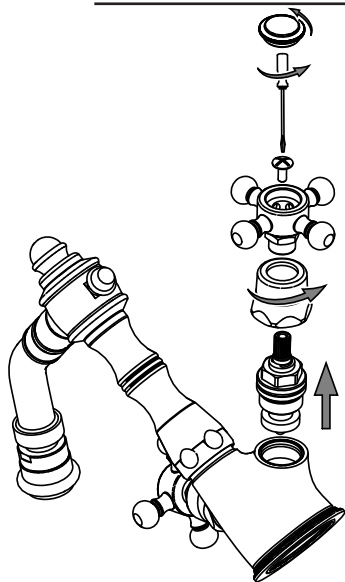

d

Sostituzione Canna How to replace Spout

b

Sostituzione Snodo How to replace Joint

c

Sostituzione Aeratore How to replace Aerator

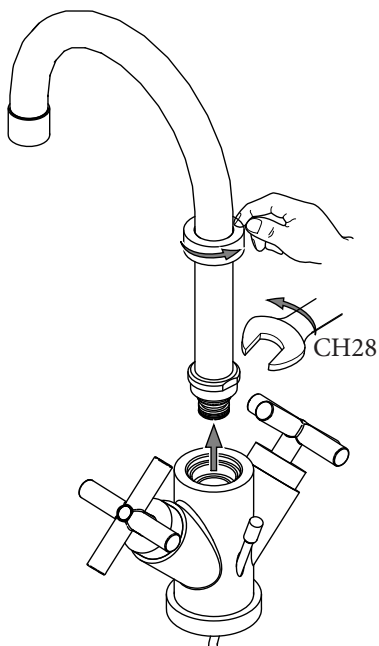
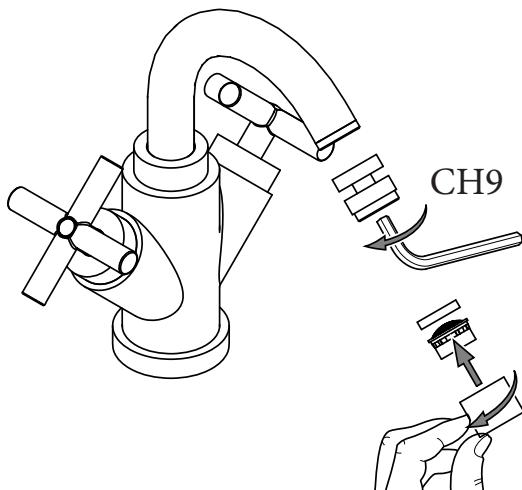

e

QTV

